

START

# The Egg Game

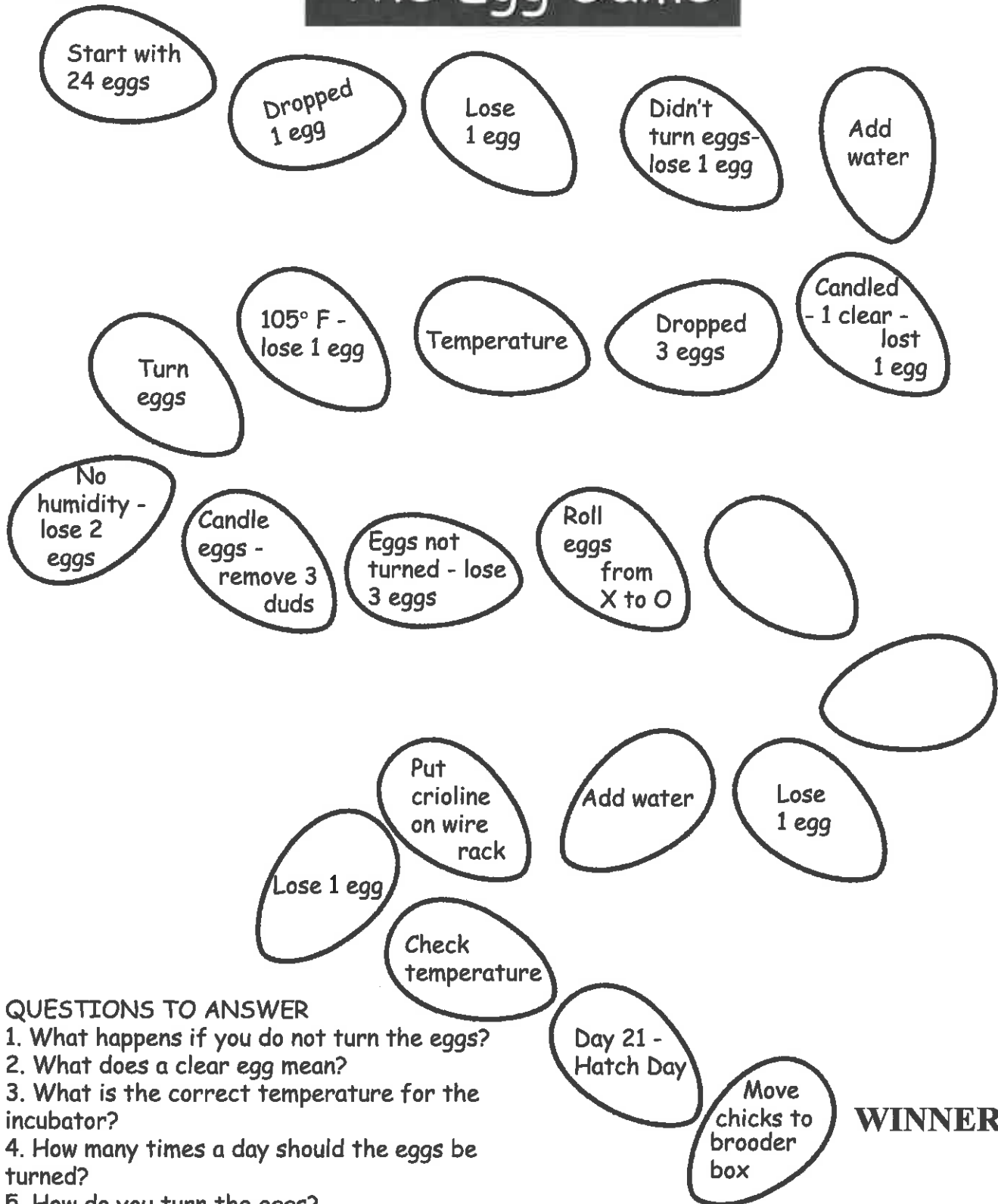

## QUESTIONS TO ANSWER

1. What happens if you do not turn the eggs?
2. What does a clear egg mean?
3. What is the correct temperature for the incubator?
4. How many times a day should the eggs be turned?
5. How do you turn the eggs?
6. How do you keep humidity in the incubator?
7. Should eggs be rotated in the incubator?
8. What is candling?
9. When should you stop turning the eggs?

Heads moves 2 spaces.  
Tails moves 1 space.

# Egg Parts

Color each part of the egg a different color and label each part of the egg.

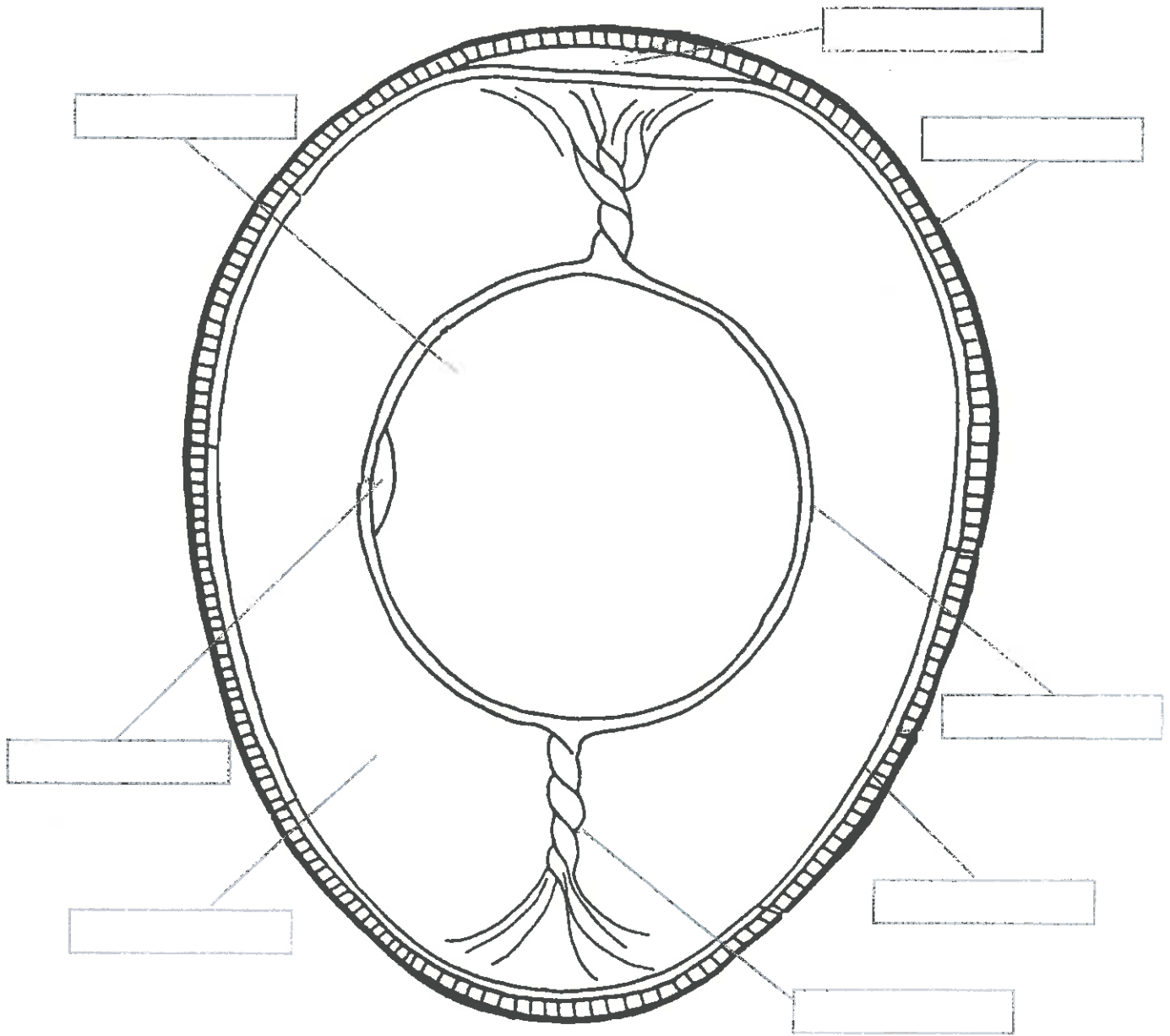

Use each word only once:

air cell  
germinal disc  
vitelline membrane

albumen or white  
membranes  
yolk

chalaza  
shell

KEY

# Egg Parts

Color each part of the egg a different color and label each part of the egg.

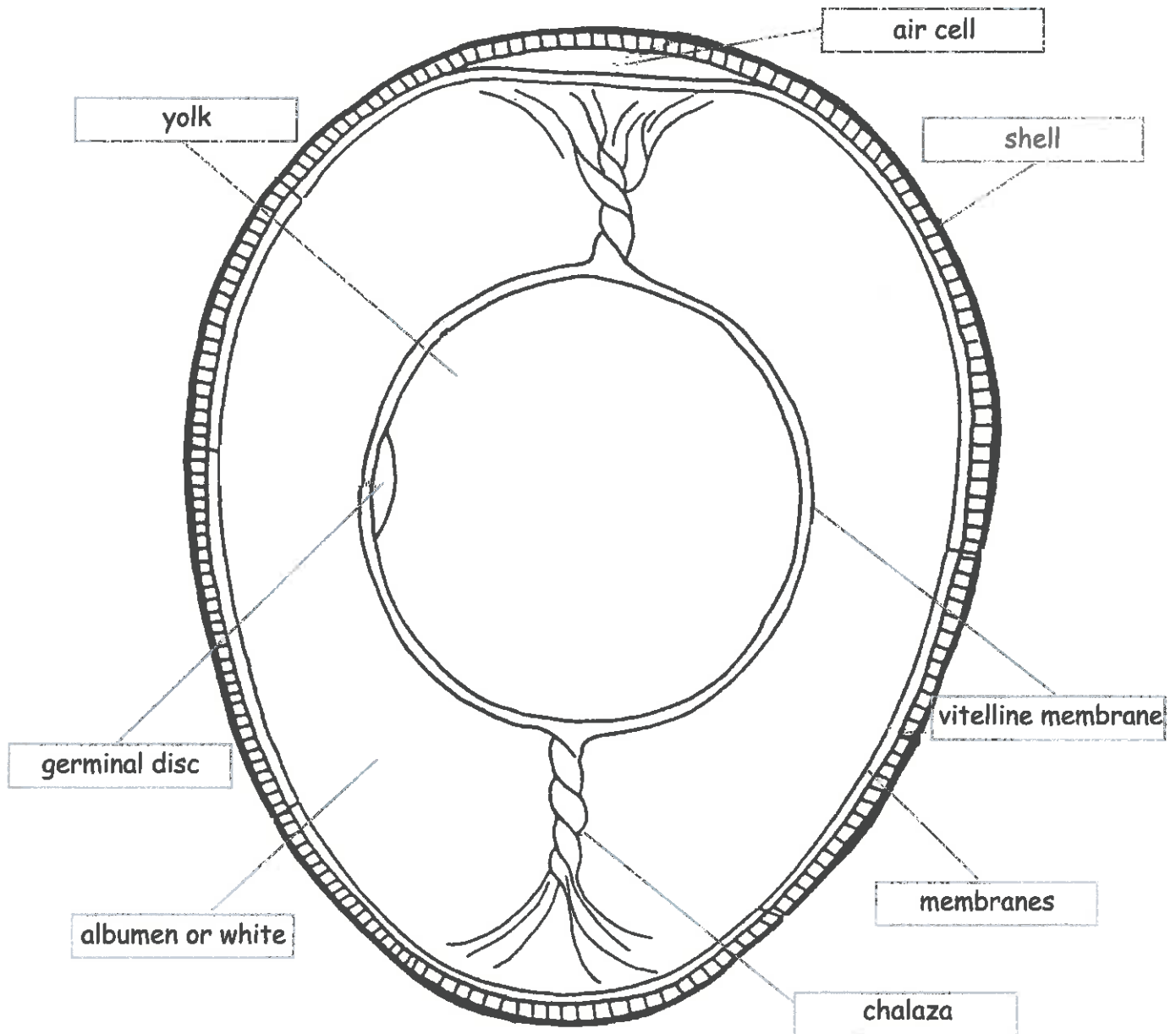

Use each word only once:

air cell  
germinal disc  
vitelline membrane

albumen or white  
membranes  
yolk

chalaza  
shell

# Parts of a Chicken

Color and label the parts of a chicken.

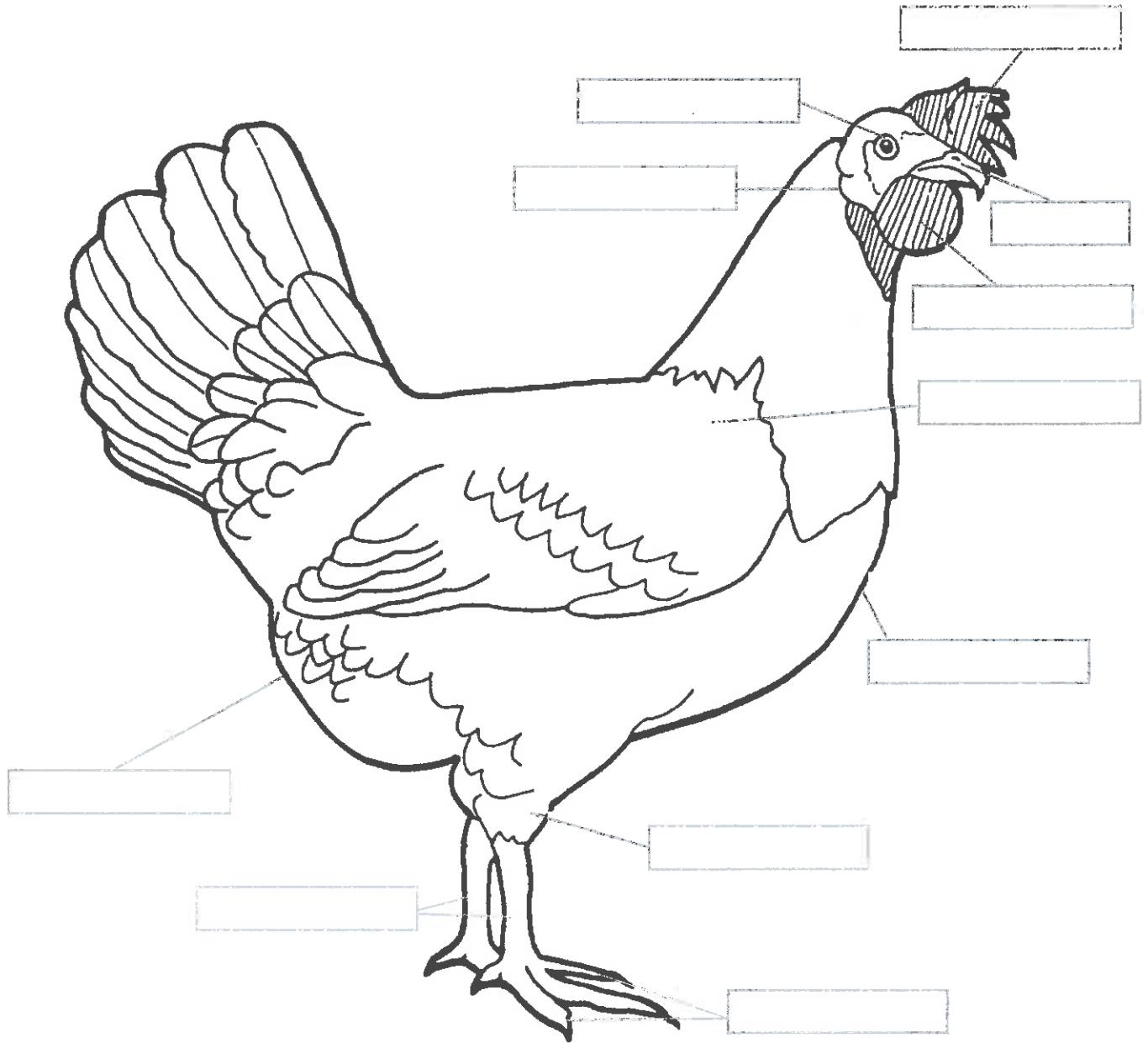

Use each word only once:

beak  
eye  
toes

breast  
hock  
vent

comb  
shanks  
wattles

ear lobe  
shoulder

**KEY**

# Parts of a Chicken

Color and label the parts of a chicken.

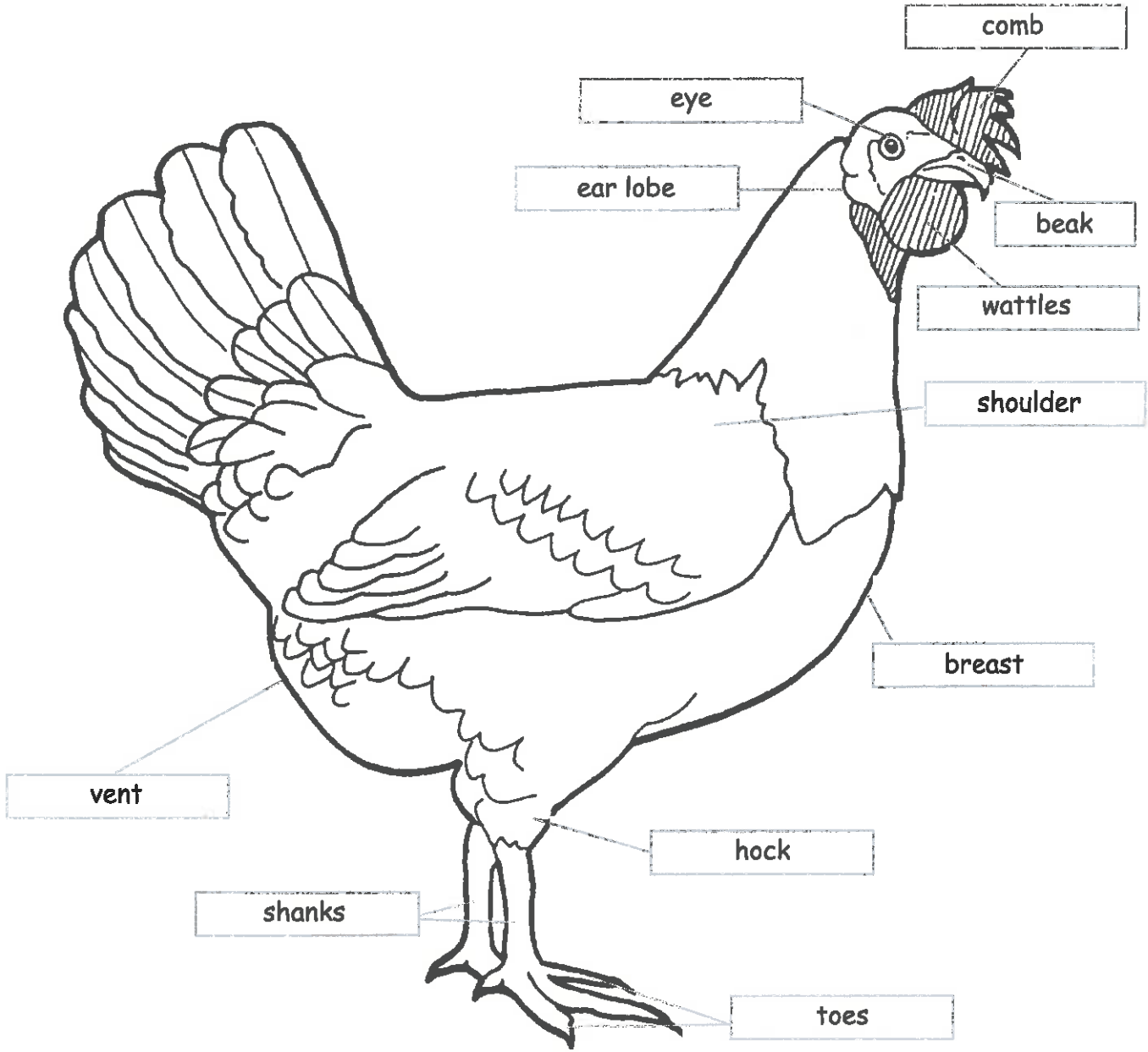

Use each word only once:

beak  
eye  
toes

breast  
hock  
vent

comb  
shanks  
wattles

ear lobe  
shoulder

# Which Egg Is Fertile?

When fertile eggs are incubated by either a hen or in an incubator, they grow.  
What is needed to make an egg fertile?

Look at the picture below and mark the fertile egg.

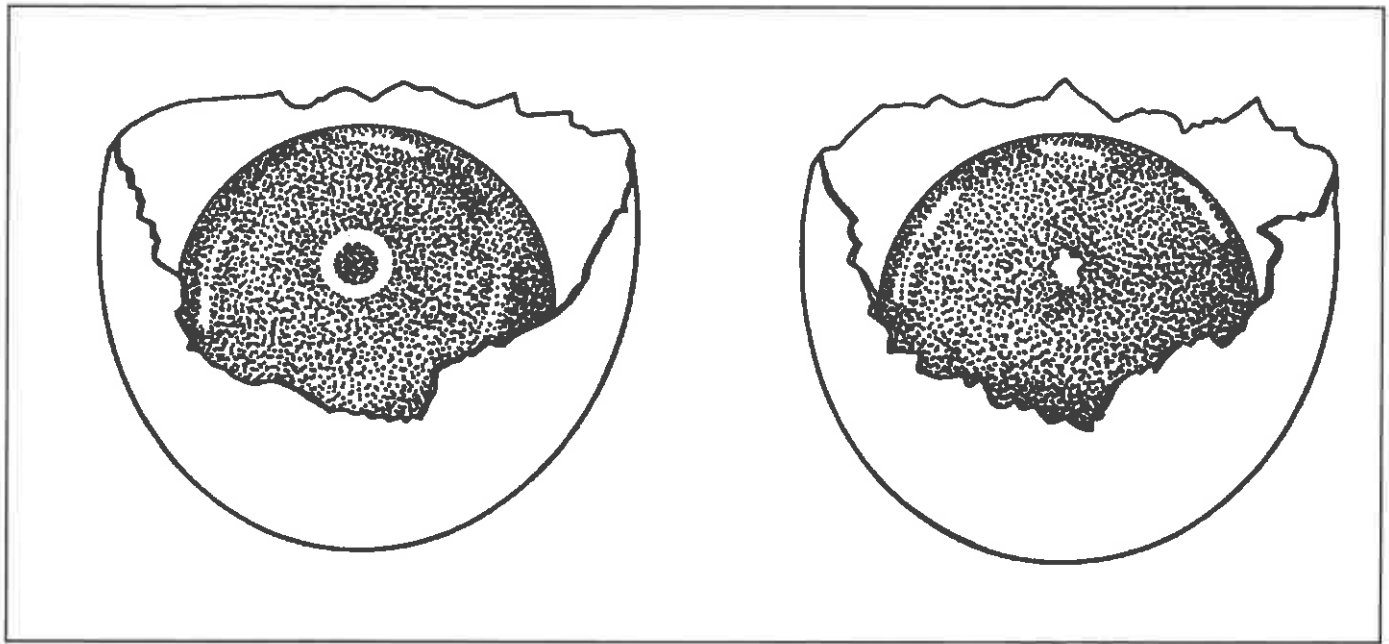

How do you know that the egg you have marked is fertile? Explain.

KEY

## Which Egg Is Fertile?

When fertile eggs are incubated by either a hen or in an incubator, they grow.  
What is needed to make an egg fertile?

Look at the picture below and mark the fertile egg.

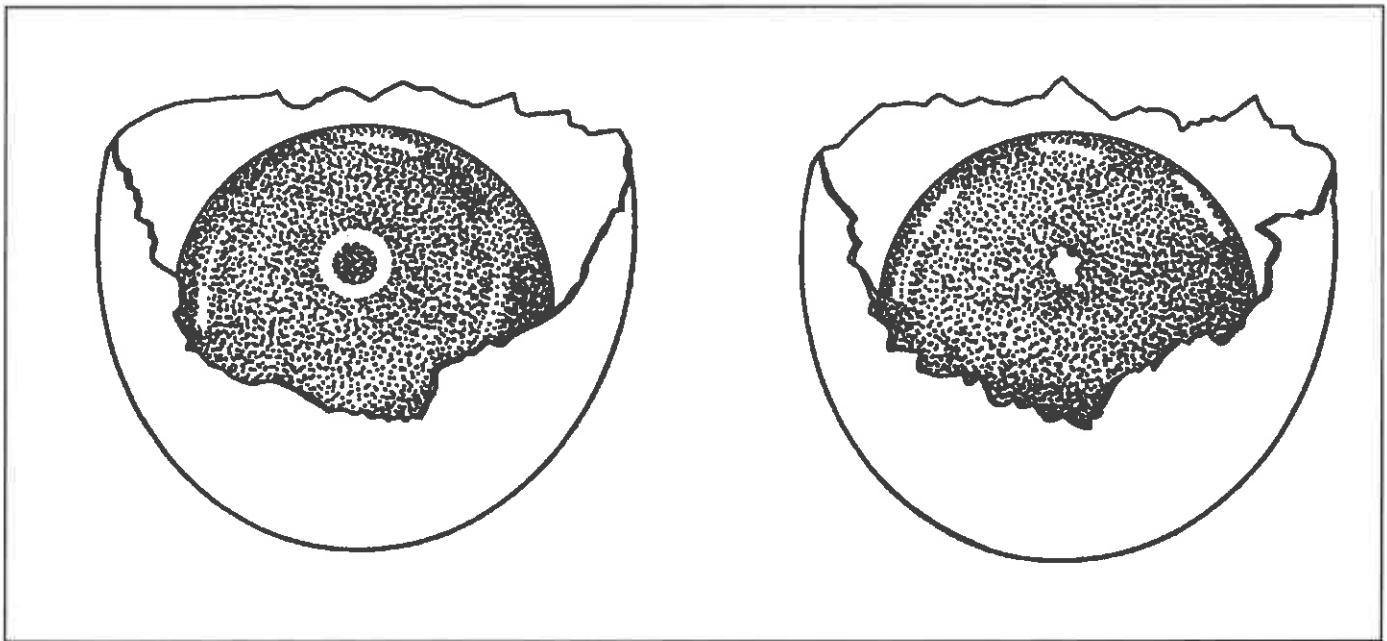

How do you know that the egg you have marked is fertile? Explain.

**The egg on the left. The germinal disc is larger in the fertile egg as compared to the infertile egg. Cell division has occurred in the fertile egg. The fertile egg has an enlarged circle or donut. Their germinal disc is small in the infertile egg.**

# Egg Sizing

Match the egg to its size.

21 oz

Pee Wee

15 oz

Medium

24 oz

Small

27 oz

Large

18 oz

Extra Large

30 oz

Jumbo



KEY

# Egg Sizing

Match the egg to its size.

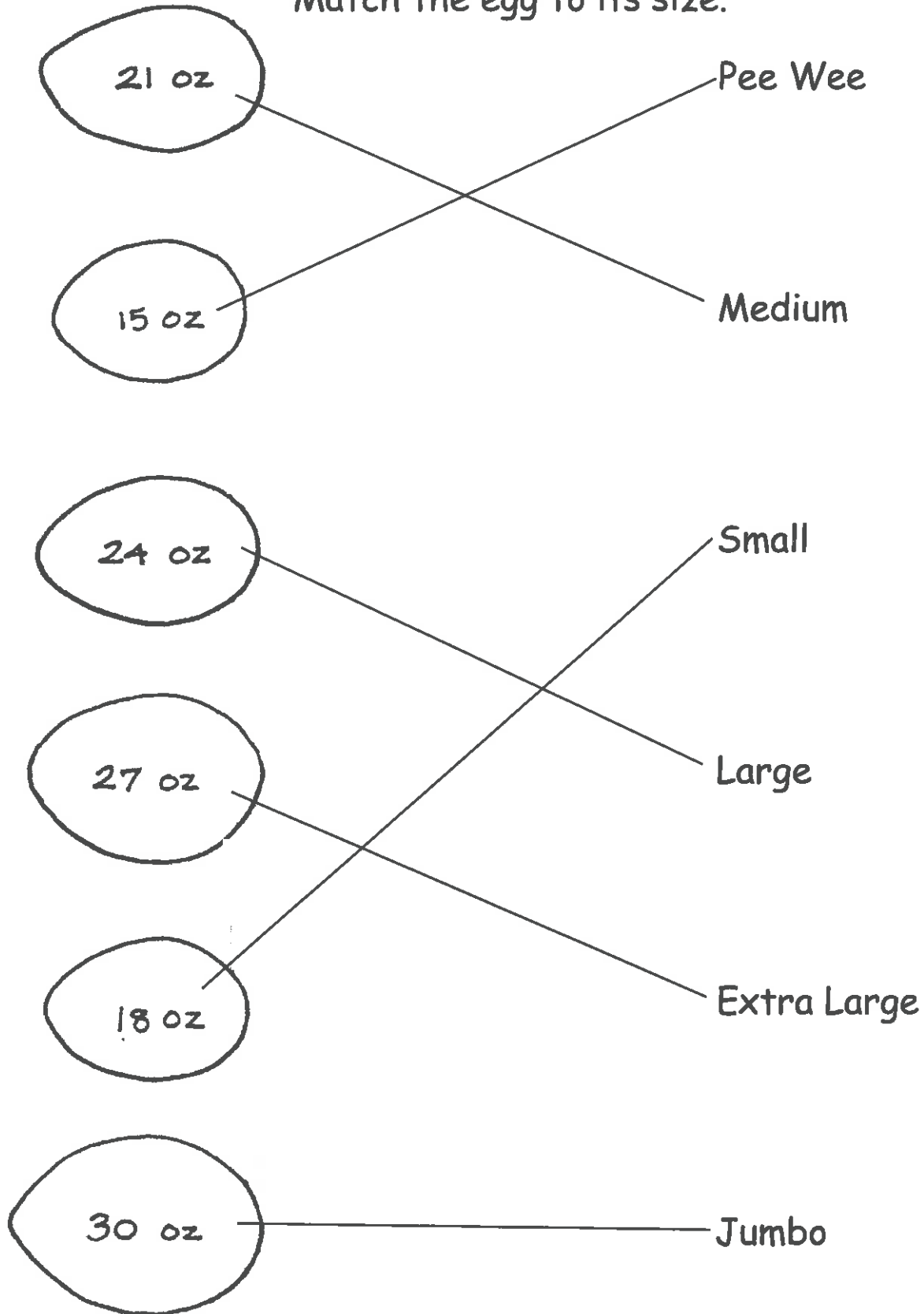

# Egg Grading

Match the egg to its grade.

Eggs are graded for quality. Read the description of each grade of egg carefully and then grade each egg in the box with AA, A, or B.

A grade AA egg stands up tall. The yolk is firm and the area covered by white is small.

A grade A egg has a yolk that is round and tall. The white is a little flatter than a grade AA egg.

A grade B egg spreads out more. The yolk is flattened.

The grade of eggs can change if eggs are not stored correctly or if eggs are kept for a long time in the refrigerator.

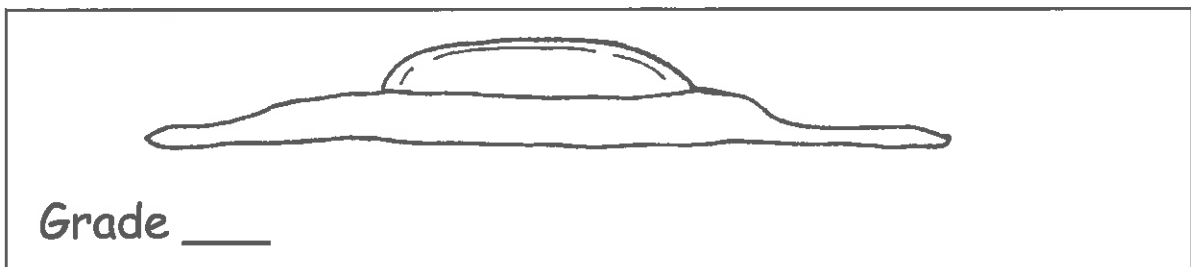
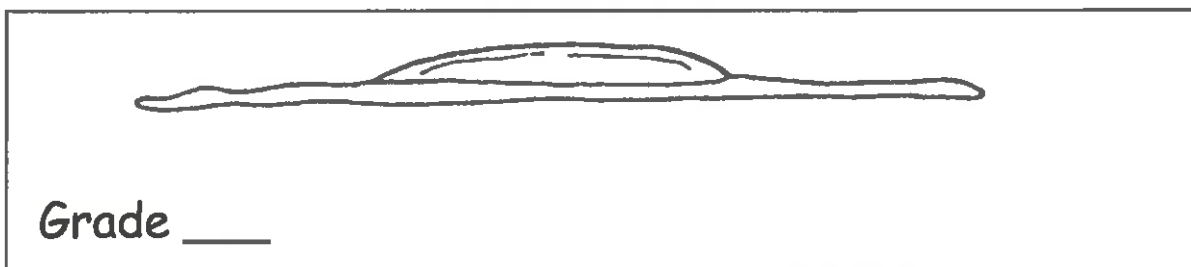
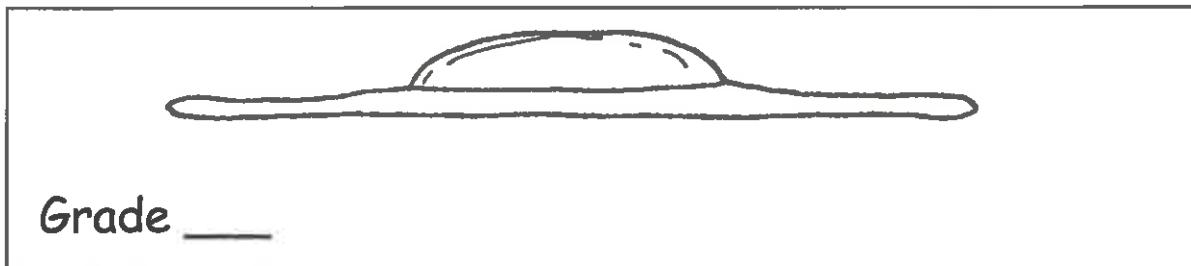

KEY

# Egg Grading

Match the egg to its grade.

Eggs are graded for quality. Read the description of each grade of egg carefully and then grade each egg in the box with AA, A, or B.

A grade AA egg stands up tall. The yolk is firm and the area covered by white is small.

A grade A egg has a yolk that is round and tall. The white is a little flatter than a grade AA egg.

A grade B egg spreads out more. The yolk is flattened.

The grade of eggs can change if eggs are not stored correctly or if eggs are kept for a long time in the refrigerator.



Grade A



Grade B



Grade AA

# What Kind of Heat?

What kind of heat is keeping the eggs warm in the "incubators?"

1.

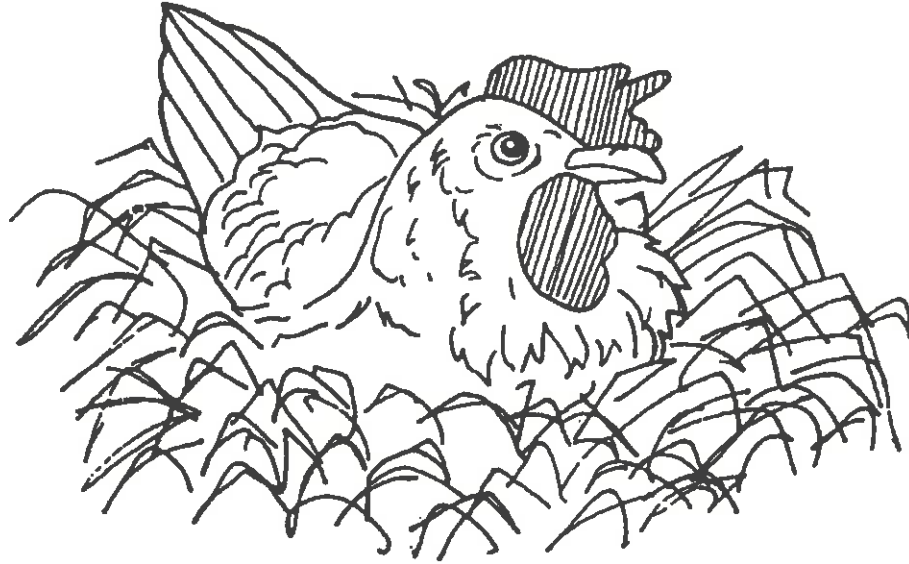

2.

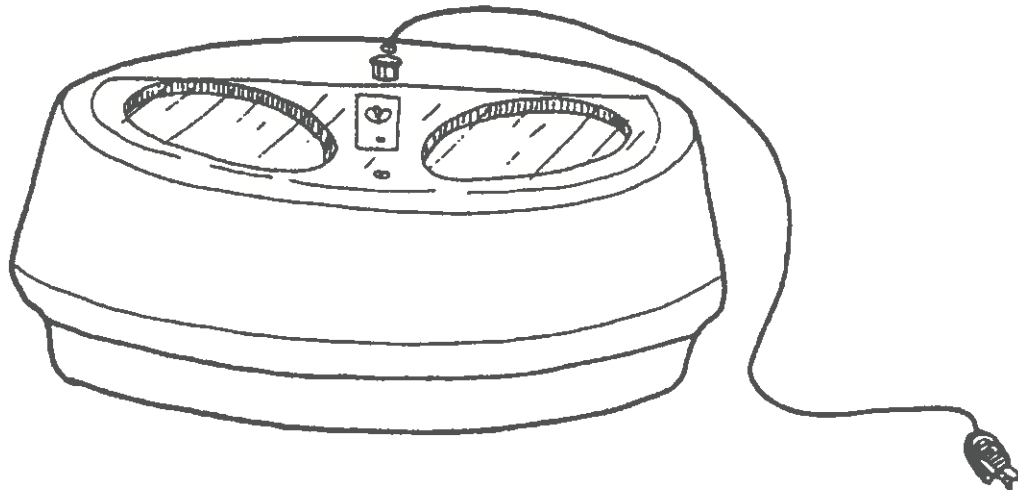

**KEY**

# What Kind of Heat?

What kind of heat is keeping the eggs warm in the "incubators?"

1.



**Natural heat - heat from the setting hen**

2.

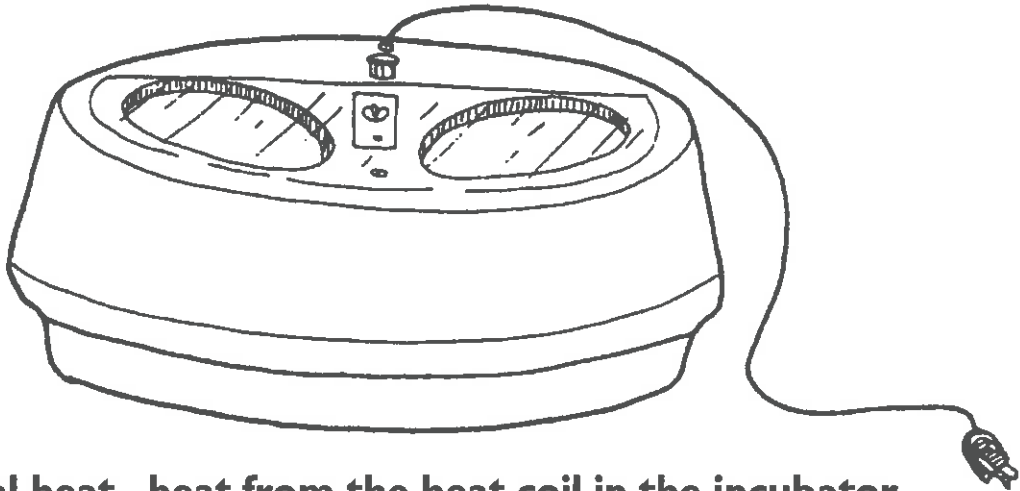

**Artificial heat - heat from the heat coil in the incubator**

# The Thermometer

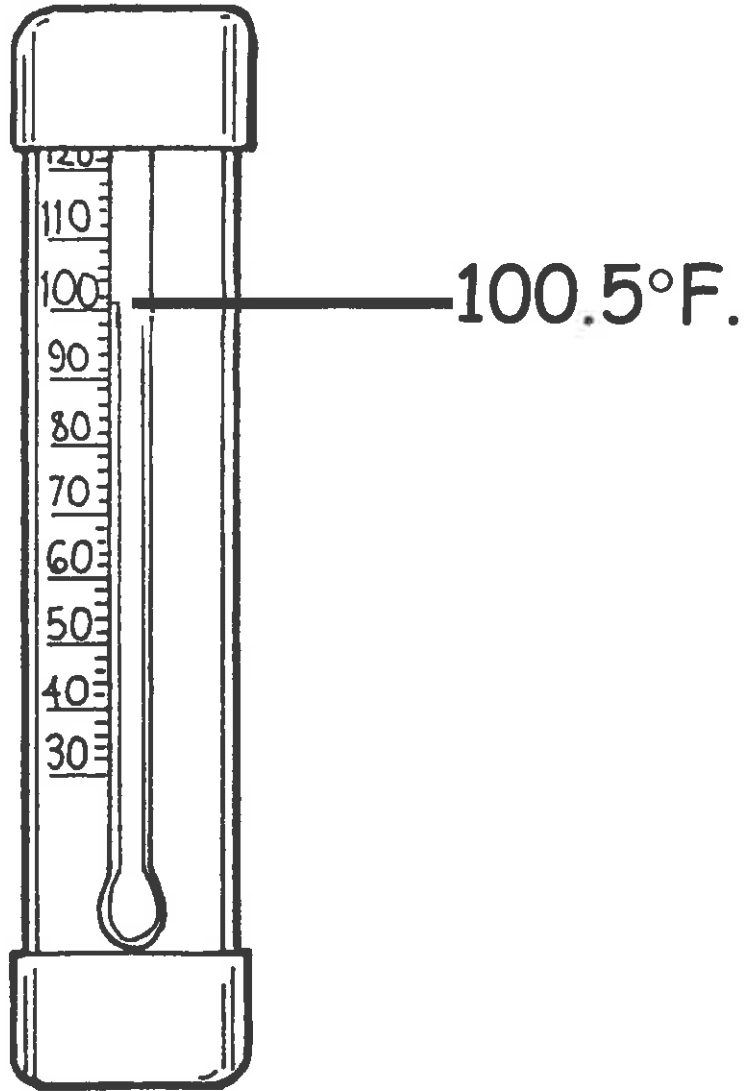

An instrument that measures temperature is a \_\_\_\_\_.

We tried to keep the temperature at \_\_\_\_\_. The temperature would \_\_\_\_\_ when the incubator was opened.

Color the mercury red.

KEY

# The Thermometer

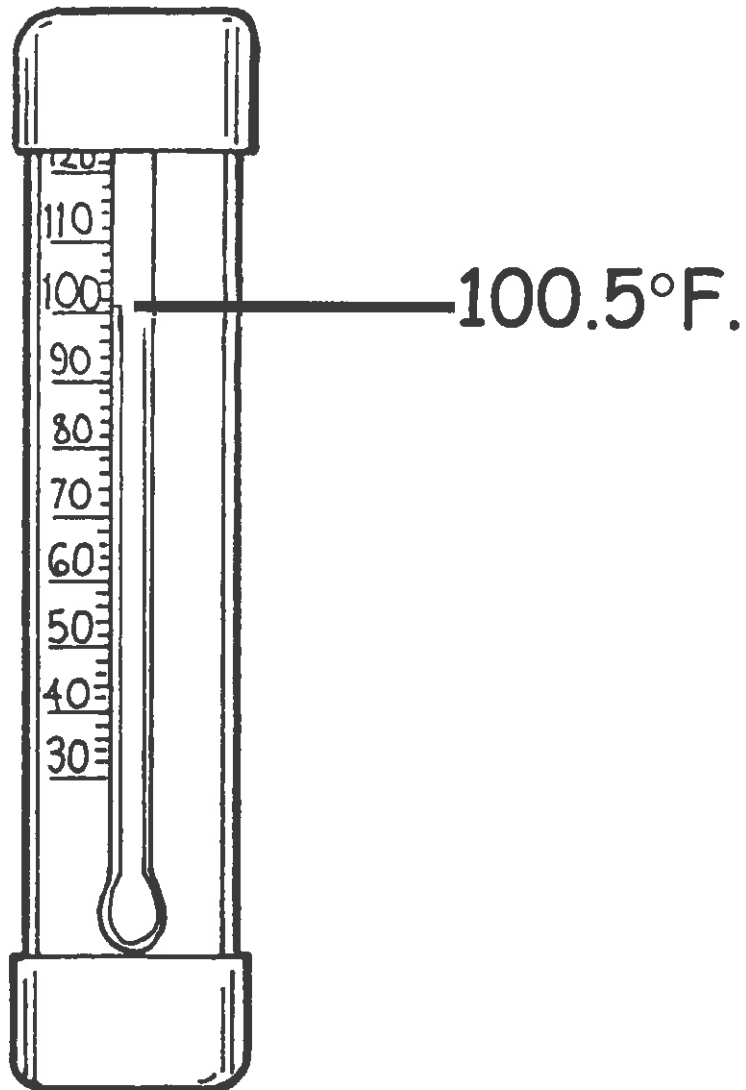

An instrument that measures temperature is a thermometer.

We tried to keep the temperature at 100.5°F. The temperature would drop when the incubator was opened.

Color the mercury red.

# Temperature Comparison Chart

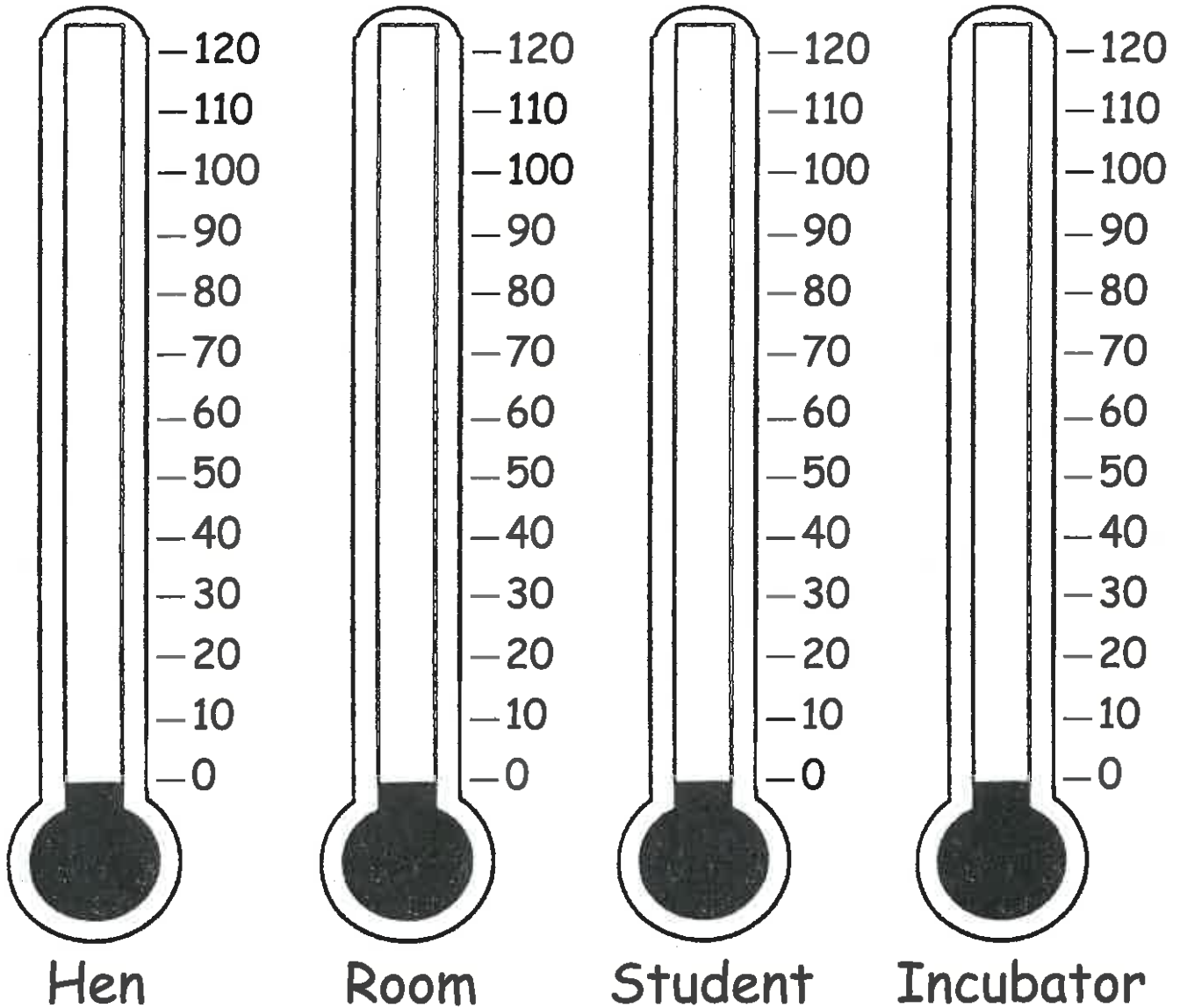

Use your red crayon, marker or pencil to show the normal temperature of a healthy hen or student, the temperature in your classroom, and the correct temperature for the incubator.

- Who or what has the **highest** temperature?
- Who or what has the **lowest** temperature?



# Temperature Comparison Chart

## KEY

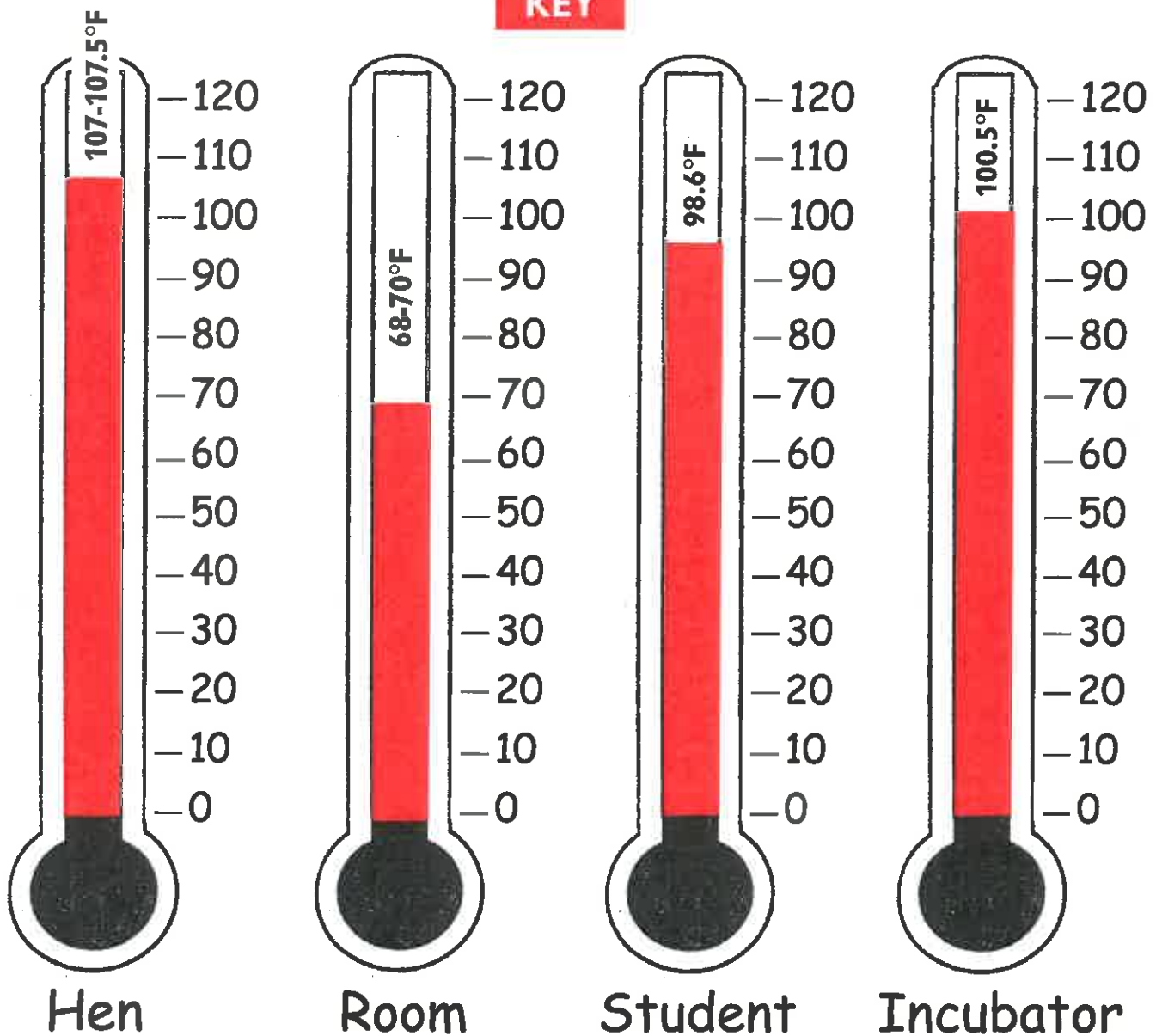

Use your red crayon, marker or pencil to show the normal temperature of a healthy hen or student, the temperature in your classroom, and the correct temperature for the incubator.

- Who or what has the **highest** temperature? **Hen**
- Who or what has the **lowest** temperature? **Room**

# Needs Comparison Chart

Needs	Baby	Chick
Food		
Water		
Protection		
Warmth		
Cleanliness		
Safety and Air		
Other		

Who provides for the needs that you have checked for the baby? Who provides the needs for the chick? Why are the needs important? How can you provide for the needs of either a baby or a chick?

**KEY**

# Needs Comparison Chart

Needs	Baby	Chick
Food	X	X
Water	X	X
Protection	X	X
Warmth	X	X
Cleanliness	X	X
Safety and Air	X	X
Other	X	X

**Babies and chicks have the same needs. The parent or care giver is responsible for the baby's care. The mother hen or the chick caregiver is responsible for the chick's care.**

# Unscramble the Scrambled Eggs

1. geg

2. hne

3. koyl

4. htcah

5. lehls

6. oymrbe

7. aekb

8. iecckhn

9. orcuibtna

10. ingsw

11. tapemertrue

12. izdeltirfe

1. \_\_\_\_\_

7. \_\_\_\_\_

2. \_\_\_\_\_

8. \_\_\_\_\_

3. \_\_\_\_\_

9. \_\_\_\_\_

4. \_\_\_\_\_

10. \_\_\_\_\_

5. \_\_\_\_\_

11. \_\_\_\_\_

6. \_\_\_\_\_

12. \_\_\_\_\_

# Unscramble the Scrambled Eggs

## KEY

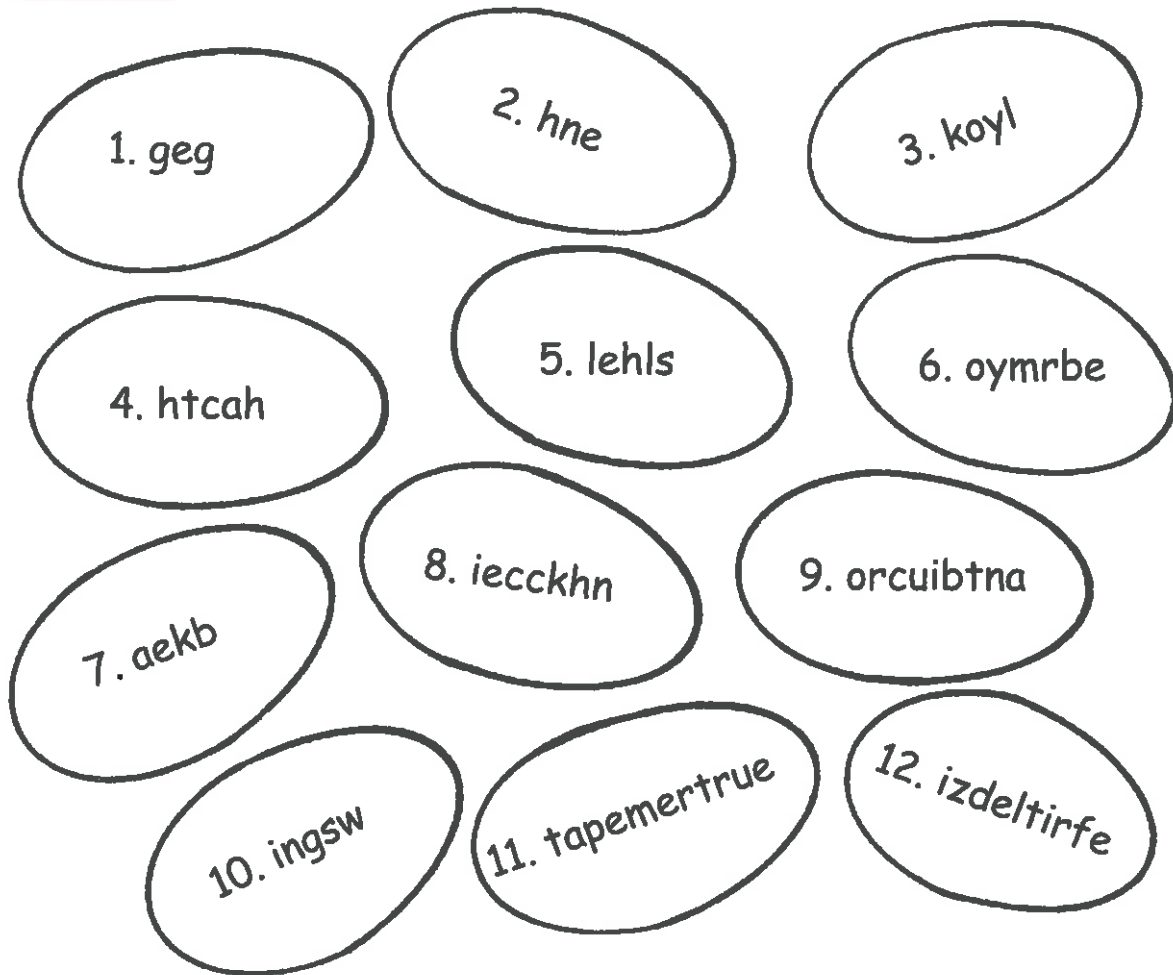

1. egg

2. hen

3. yolk

4. hatch

5. shell

6. embryo

7. beak

8. chicken

9. incubator

10. wings

11. temperature

12. fertilized

# Hidden Words

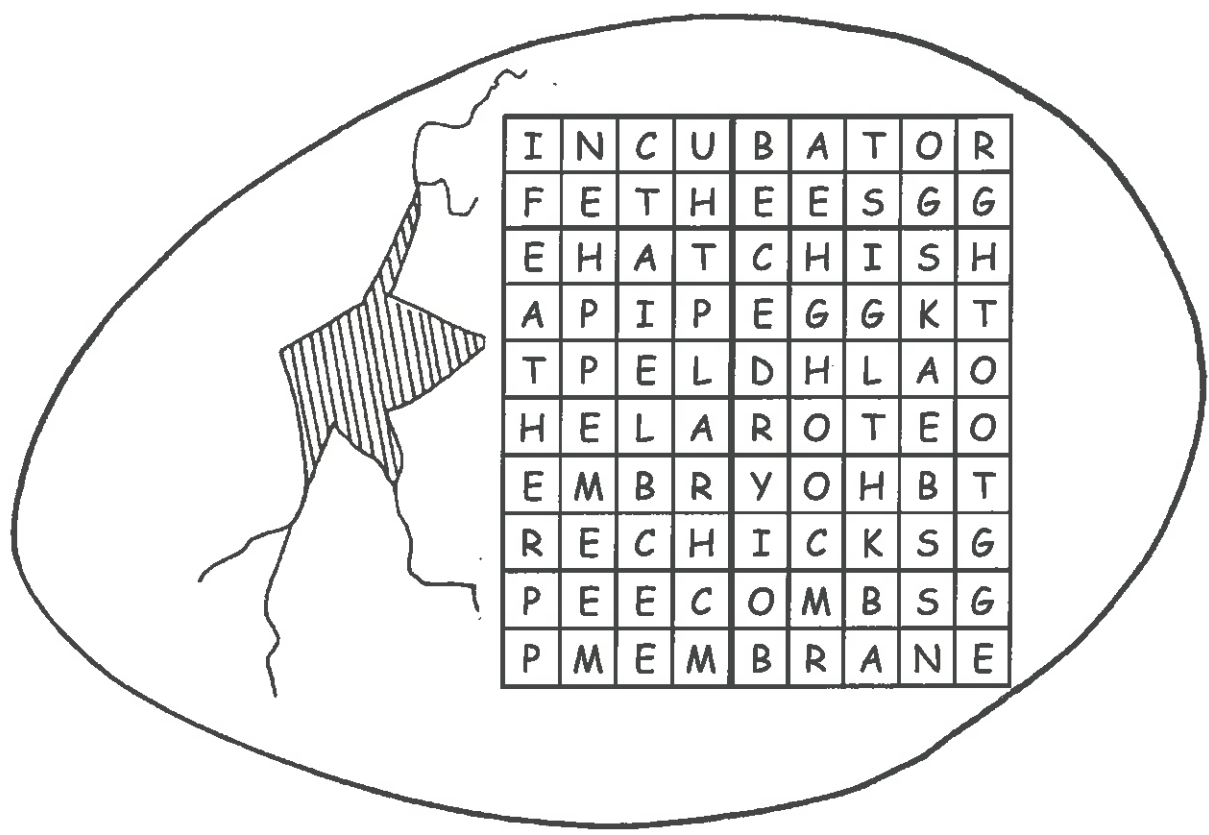

Circle the hidden words on the list. The words can be hidden up, down or diagonally. When you have finished, use the left over letters to find a message. What is the message?

The message is \_\_\_\_\_

Words to find		
egg	hatch	egg tooth
embryo	feather	hen
membrane	shell	beak
incubator	yolk	combs

# Hidden Words

**KEY**

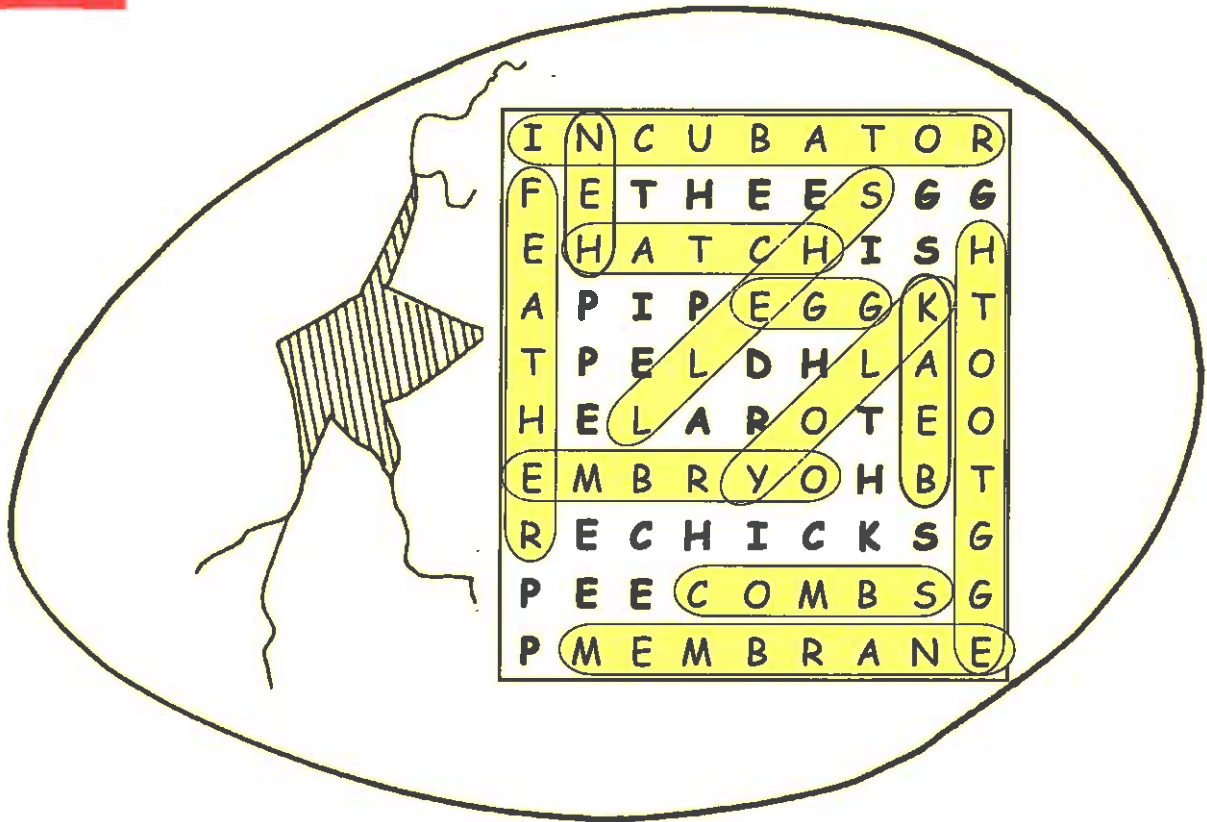

Circle the hidden words on the list. The words can be hidden up, down or diagonally. When you have finished, use the left over letters to find a message. What is the message?

The message is THE EGG IS PIPPED HEAR THE CHICKS PEEP

Words to find		
egg	hatch	egg tooth
embryo	feather	hen
membrane	shell	beak
incubator	yolk	combs

# Science Vocabulary

Put these words in alphabetical order.

hatch	chicken	temperature
peeps	egg tooth	membrane
heart	rooster	blood vessels
egg	hen	incubator
beak	chick	fertilized
yolk	embryo	development
white	sac	thermometer
shell	wings	feathers

- |           |           |
|-----------|-----------|
| 1. _____  | 13. _____ |
| 2. _____  | 14. _____ |
| 3. _____  | 15. _____ |
| 4. _____  | 16. _____ |
| 5. _____  | 17. _____ |
| 6. _____  | 18. _____ |
| 7. _____  | 19. _____ |
| 8. _____  | 20. _____ |
| 9. _____  | 21. _____ |
| 10. _____ | 22. _____ |
| 11. _____ | 23. _____ |
| 12. _____ | 24. _____ |

Choose 12 vocabulary words. Use each word in a complete sentence.



**KEY**

# Science Vocabulary

Put these words in alphabetical order.

hatch	chicken	temperature
peeps	egg tooth	membrane
heart	rooster	blood vessels
egg	hen	incubator
beak	chick	fertilized
yolk	embryo	development
white	sac	thermometer
shell	wings	feathers

- |                         |                        |
|-------------------------|------------------------|
| 1. <b>beak</b>          | 13. <b>hen</b>         |
| 2. <b>blood vessels</b> | 14. <b>incubator</b>   |
| 3. <b>chick</b>         | 15. <b>membrane</b>    |
| 4. <b>chicken</b>       | 16. <b>peeps</b>       |
| 5. <b>development</b>   | 17. <b>rooster</b>     |
| 6. <b>egg</b>           | 18. <b>sac</b>         |
| 7. <b>egg tooth</b>     | 19. <b>shell</b>       |
| 8. <b>embryo</b>        | 20. <b>temperature</b> |
| 9. <b>feathers</b>      | 21. <b>thermometer</b> |
| 10. <b>fertilized</b>   | 22. <b>white</b>       |
| 11. <b>hatch</b>        | 23. <b>wings</b>       |
| 12. <b>heart</b>        | 24. <b>yolk</b>        |

Choose 12 vocabulary words. Use each word in a complete sentence.

# Crossword Puzzle

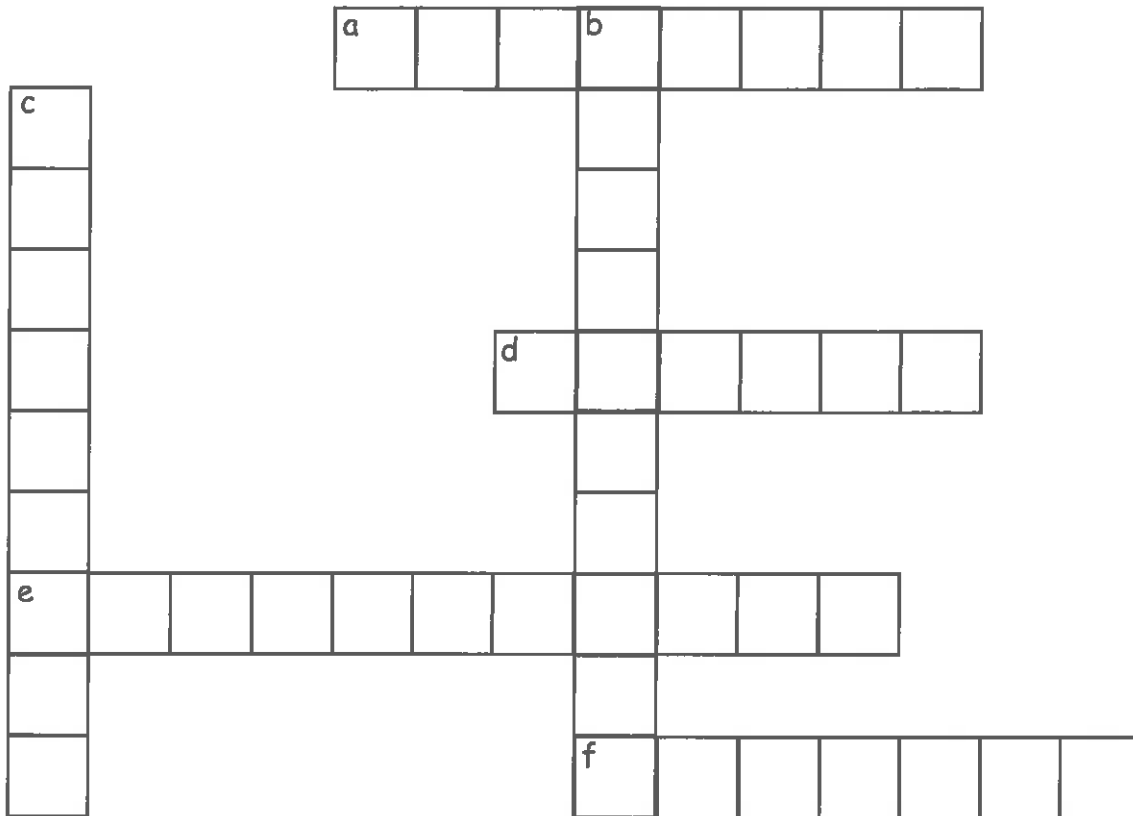

- a. (across) What heats the incubator? (two words)
- b. (down) What controls the light bulb and the heat in the incubator?
- c. (down) What do you use to incubate eggs?
- d. (across) What do you call an unborn chick?
- e. (across) What does a thermometer measure?
- f. (across) What job must be done with the eggs three or more times a day?

KEY

Crossword Puzzle

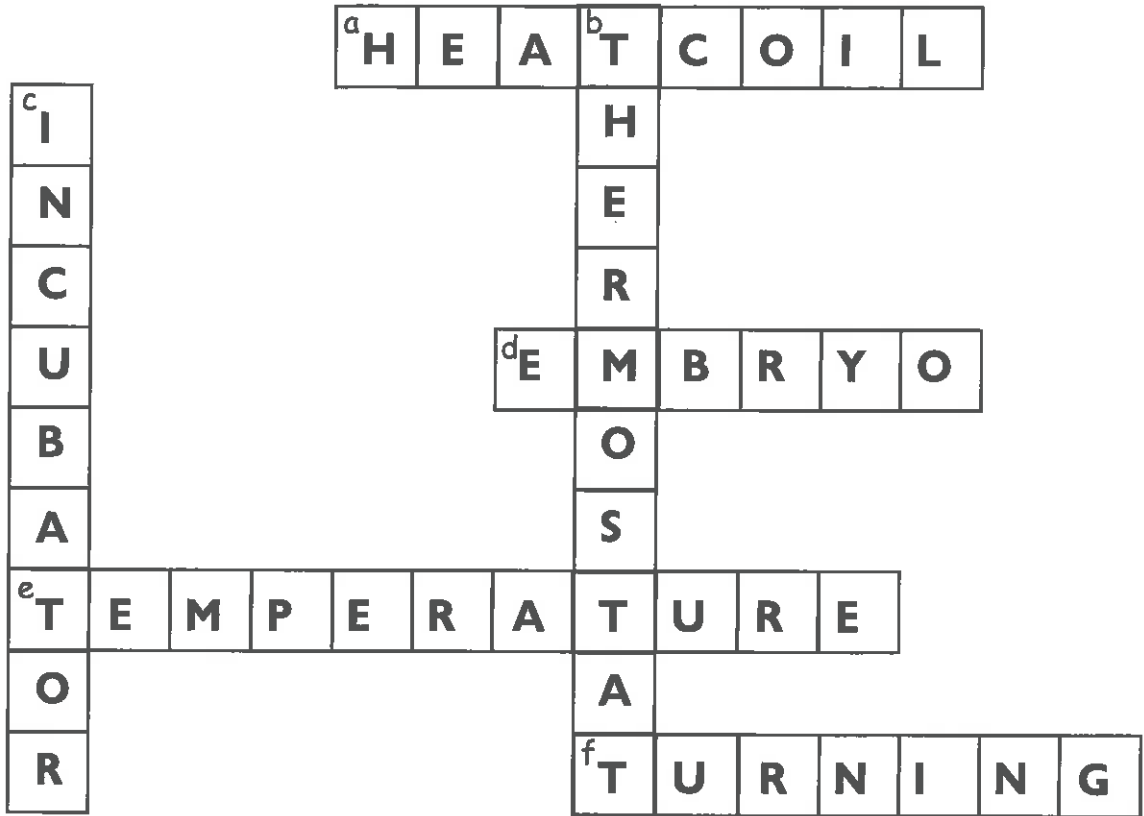

- a. (across) What heats the incubator? (two words)
- b. (down) What controls the light bulb and the heat in the incubator?
- c. (down) What do you use to incubate eggs?
- d. (across) What do you call an unborn chick?
- e. (across) What does a thermometer measure?
- f. (across) What job must be done with the eggs three or more times a day?